

Owner's Manual



➤ S930A



➤ S940A

PRODUCT SAFETY SYMBOLS

The symbols below are used on the scooter to identify warnings, mandatory actions, and prohibited actions.

It is very important for you to read and understand them completely.

HAZARD IDENTIFICATION

The hazard identification surround shape is represented as a yellow symbol on a black triangle with a black border. It is used to indicate a potentially hazardous condition/situation that could result in personal injury, component damage, or malfunction.



Pinch/Crush points created during assembly.



Read and follow the information in the owner's manual.



Never attempt to get onto or off of your mobility product without first ensuring the unit is powered off.



— Unlocked and in freewheel mode.

Place unit on level ground and stand to one side when changing from drive mode to freewheel mode or freewheel mode to drive mode.

— Locked and in drive mode.



Indicate stiller angle adjustment.



Indicate forward and backward.

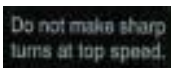

Do not make sharp turns at top speed.



Emergency use only.



Maximum load capacity 450lbs/202kg.



Batteries on here.

! WARNING

For your safety, please read the owner's manual before operating this product. Before reading through the owner's manual, please do not operate the product.

! WARNING

For your safety, when you operate the scooter or before you operate the scooter, if you find any problem, please stop operating the scooter immediately and contact with the dealer for solving the problem.

! WARNING

For your safety, the user should be comply with the following condition for operating the scooter:

1. Spirits in good condition, can clearly distinguish the surroundings condition and physical function are normal to operate the scooter.
2. After drinking or eating of alcoholic beverages or food, do not operate the product.
3. Before operating the scooter, do not take medicine which might affects sanity or mental state.

! WARNING

For your own safety, Visually Impaired person can not operate this product





What should you have in your carton?

1. Scooter
2. Seat
3. Headrest
4. Armrests
5. Owner's manual
6. Keys
7. Charger
8. Power cord
9. Mirror

SPECIFICATION

Model Number	S940 (4-Wheels)	S930 (3-Wheels)
Max. speed up to	12 kph / 7.5 mph ; 15 kph / 9.6 mph	
Range Up To	88 km/55 mil	
Turning Radius	210 cm/82.7 in	135 cm/53.2 in
Ground Clearance	13 cm / 5.1 in	
Motor	650W	
Controller	PG S-Drive 140 ; Rhino II 160A	
VRLA(valve-regulated lead-acid) Battery	12V / 100AH x 2PCS	
Charger	Max. 8A Off-board (Note)	
Gradient	10°	
Front Wheel	14"	
Rear Wheel	16"	
Brake	Intelligent,regenerative and electromagnetic brakes	
Overall Length	154 cm / 60.6 in	
Overall Width	72 cm / 28.3 in	
Total Weight Without Batteries	102 kg / 224 lb	
Weight Capacity	204 kg / 450 lb	
Seat Weight	20 kg / 44 lb (each)	
Battery Weight	30 kg / 67 lb (each)	

The product meets all the requirements of ISO 7176-14:2008. Forces necessary to operate the control devices: engaging 45N,disengaging 60N,speed control 3N, push buttons 4N.

This specification is for universal use and real spec may vary by regions and countries.
Note : Depends on the specifications of the accompanied charger.

Contents

1. INTRODUCTION	07
2. SAFETY	08
3. YOUR SCOOTER	14
4. BATTERY AND CHARGING	23
5. OPERATION	28
6. COMFORT ADJUSTMENT	34
7. CARE AND MAINTENANCE	37
8. LIMITED WARRANTY	42

1. INTRODUCTION

1. INTRODUCTION

Congratulations on the purchase of your new scooter! The scooter features cutting edge technology with safety, comfort in mind. We wish to thank you for letting us improve your freedom and independence.

Intended use : for disabled person to improve their mobility ,by driving by themselves.

This model has been designed with your practical needs. It is equipped with modern high-tech electronics and special features for more comfortable ride. Its safety and performance will provide you with years of excellent service and pleasure.

We want to hear your questions, comments, and suggestions about this manual and scooter.

Seat

The level of resistance to ignition of materials and assemblies : Materials are tested according to EN1021-1, -2(seat, armrests).

Note

The product comply with EN 12184 Class C standard

2. SAFETY

2. SAFETY

Read well before operation

Read and follow all instructions, warnings, and notes in this manual and all other accompanying literature before operate this product for the first time. In addition, your safety depends upon you, as well as your provider, caretaker, or healthcare professional in using good judgement.

If there is any information in this manual which you don't understand, or if you require additional assistance for setup or operation, please contact your dealer. Failure to follow the instructions, warnings, and notes in this manual and those located on your product can result in personal injury or product damage and will void our product warranty.

Modification



WARNING

Do not modify your scooter or change the programmed parameters of your scooter controller in any way. Do not use any accessories if they have not been tested or approved. These may result in personal injury and damage the scooter. Only from the manufacturer authorized personnel may perform any adjustments for you.

Pre-ride safety check

Get to know the feel of your scooter and its capabilities. We recommend that you perform a safety check before each use to make sure your scooter operates smoothly and safely.

Find an open area such as a park and have an assistant to help you practice until you have confidence operating the vehicle.

- Check for proper tire inflation.
- Make sure all electrical connections are tight and not corroded.
- Check the brakes.
- Check the battery charge.

2. SAFETY

Tire inflation

Your scooter is equipped with pneumatic tires, you should have the air pressure checked at least once a week. Proper inflation pressures will prolong the life of your tires and help ensure the smooth operation of your scooter.

WARNING

Do not underinflate or overinflate your tires. Low pressure may result in loss of control, and overinflate may burst. It is very important that 35psi (2.4 bar) tire pressure be maintained in pneumatic tires at all times.

Weight limitations

Stay within the specified weight capacity for your scooter. Exceeding the weight capacity voids your warranty. We will not be held responsible for injuries or property damage resulting from failure to observe weight limitations.

WARNING

Do not carry passengers on your scooter. Carrying passengers on your scooter may affect the center of gravity, resulting in a tip or a fall.

WARNING

User can not modify the controller parameters, it may result in personal injury and damage to your scooter.

2. SAFETY

Incline information

Now buildings have ramps with specified degree of inclination, designed for easy and safe access. Pay attention when driving down a incline and keep the scooter's speed adjustment set to the slowest speed setting to ensure a safely controlled descent. Avoid sudden stops and starts on the ramps.

! WARNING

- When climbing an incline, try to keep your scooter moving. If you must stop, start up again slowly and accelerate cautiously. When driving down an incline, set your scooter the slowest setting and drive in the forward direction only.
- Do not zigzag or drive at an angle up the face of the incline. Drive your scooter straight up the incline. This greatly reduces the possibility of a tip or a fall. Always exercise extreme caution when negotiating an incline.
- You should not travel up or down a potentially hazardous inline, such as area covered with snow, ice, cut grass, or wet leaves.
- When on any sort of incline or decline, never place the scooter in "Free wheel" mode while seated on it or standing next to it. It may result in personal injury and damage to your scooter. Never travel down an incline backwards, it may result in personal injury.

(Picture 2.1 with driving position- Increased stability driving position)

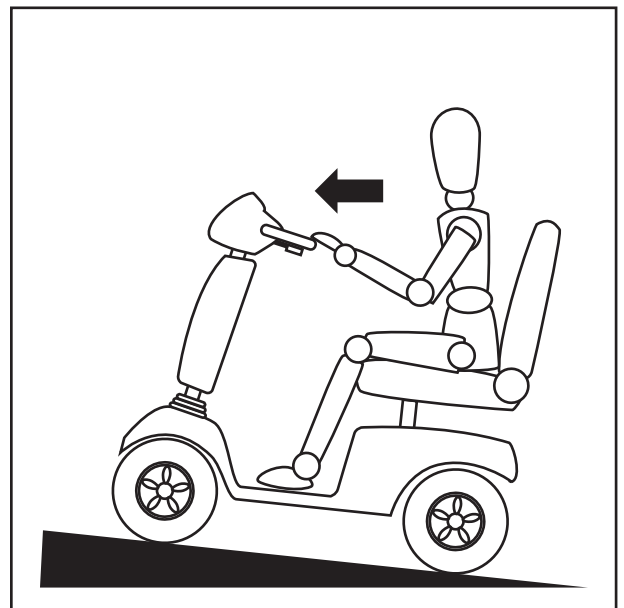

Picture 2.1 Incline information

2. SAFETY

Braking information

Your scooter is equipped with these powerful braking systems:

Electromagnetic regenerative brake: Uses electricity to rapidly slow the vehicle when the throttle control lever returns to the center/stop position and act as a parking brake.

Manual brake : Activates mechanically when power is removed from the system for any reason. The manual brake is not a parking brake. It can be used as a running brake in freewheel mode.

In freewheel mode an assistant has to operate the parking brake by engaging the drive system again. No battery power is necessary for this function.

Outdoor driving surface

Avoid driving on uneven terrain or soft surface.

Avoid tall grass that can become tangled in the running gear.

Avoid loosely packed gravel and sand.

If you feel unsure about a driving surface, avoid the surface.

Obstacles (steps, curbs, etc)

Do not attempt to have your scooter proceed backward down any step, curb, or other obstacle. This may cause the scooter to tip. We recommend that you do not attempt to negotiate a curb that has a height greater than 4 in. (10 cm). With in 500mm run-up. Doing so could cause instability in your scooter.



Picture 2.2 Obstacles information

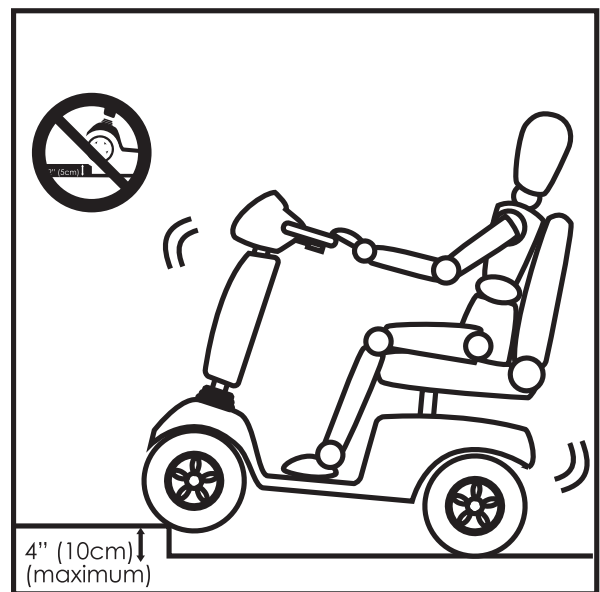

Picture 2.3 Obstacles information

2. SAFETY

Inclement weather precautions

Exposure of your scooter to inclement weather conditions should be avoided whenever possible. If suddenly caught up in rain, snow, severe cold or heat while operating your scooter, proceed to shelter at the earliest opportunity. Thoroughly dry your scooter before storing, charging, or operating your scooter.

Freewheel mode

When your scooter is in freewheel mode, the braking system is disengaged. Disengage the drive motors only on a level surface. Stand to the side of the scooter to engage or disengage freewheel mode. Do not sit on a scooter to do this. The freewheel mode is only to use with an assistant, who is able to engage again in a hazardous situation.

Stairs and elevators

Electric scooter is not designed to travel down or up stairs or escalators. Always use an elevator. Drive your scooter gently and slowly forward to push the door open. Or drive your scooter gently and slowly rearwards to pull the door open.

Batteries

Scooter batteries are heavy, if you are unable to lift it, be sure to get help. Always protect the batteries from freezing. Charging a frozen battery may result in damage to the battery. Connect the battery harnesses in the proper manner.

2. SAFETY

Transport

Do not remain seated in your scooter while traveling in a motor vehicle. The scooter should be stowed in the trunk of a car with batteries removed and properly secured. All scooter parts should be removed and properly secured during motor vehicle transport.

Getting onto and off scooter

Getting onto and off of your scooter requires a good sense of balance. Please following the safety tips when getting onto and off of your scooter :

- Remove the key from the key switch.
- Ensure that your scooter is not in freewheel mode.
- Make certain that the seat is fixed into place.



WARNING

Avoid putting all your weight on the scooter armrests and do not use the armrests for weight bearing purposed, such as transfers. It may cause the scooter to tip, resulting in a fall from the scooter.

Alcohol

Do not operate your scooter while you are under the influence of alcohol, as this may impair your ability to drive safely.

Pre-sale information

What people can not use this scooter: mentally handicapped people, persons with insufficient eyesight, one-hand people, children under 6 years, drunken people.

Position belts is optional kit. For installing the position belt, please kindly contact with the dealer.

Note

This product can be used for temperature $-25^{\circ}\text{C} \sim 50^{\circ}\text{C}$ on the hard ground environment.

3. YOUR SCOOTER

3. YOUR SCOOTER

Controls (Digital dashboard)

The tiller includes the speed adjustment knob, throttle control lever, LCD display, half speed button, hazard light button, headlight button, turn signal buttons, and horn button.



WARNING

User can not modify the controller parameters, it may result in personal injury and damage to your scooter.

Speed Adjustment Knob

This dial allows you to preselect and limit your scooter's top speed. The image of the turtle represents the slowest speed setting. The image of the hare represents the fastest speed setting.

Throttle Control Lever

This lever allows you to control the forward speed and the reverse speed of your scooter up to the maximum speed you preset with the speed adjustment dial.

To Move Forward use either of the following:

- Use your left thumb to push the left side of the throttle control lever.
- Use your right hand fingers to pull back on the right side of the throttle control lever.

To Move Rearward use either of the following:

- Use your right thumb to push the right side of the throttle control lever.
- Use your left hand fingers to pull back on the left side of the throttle control lever.

Release the throttle control lever and allow your scooter to come to a complete stop before engaging the other side of the lever. When the throttle control lever is completely released, it automatically returns to the center "stop" position and engages your scooter's brakes.

Hazard Light Button

The hazard light is activated by pressing the hazard light button. The hazard light of the indicator light area will light up when pressing the button. Pressing the button a second time will turn it off.

3. YOUR SCOOTER

Turn Signals

Left turn signals button: Pressing the button will activate the left turn signal lights. The turn signals of the indicator light area will light up when pressing the button. Pressing a second time will turn it off.

Right turn signals button: Pressing the button will activate the right turn signal lights. The turn signals of the indicator light area will light up when pressing the button. Pressing a second time will turn it off.

Battery Condition Meter

When the key is fully inserted and turned clockwise to power up your scooter, LCD shows battery voltage condition. If the battery voltage is low, the batteries need to be charged as soon as possible. If the battery voltage is high, the batteries are fully charged.

Headlight Button

The headlight is activated by pressing the headlight button. The headlight of the indicator light area will light up when pressing the button. Pressing the button a second time will turn it off.

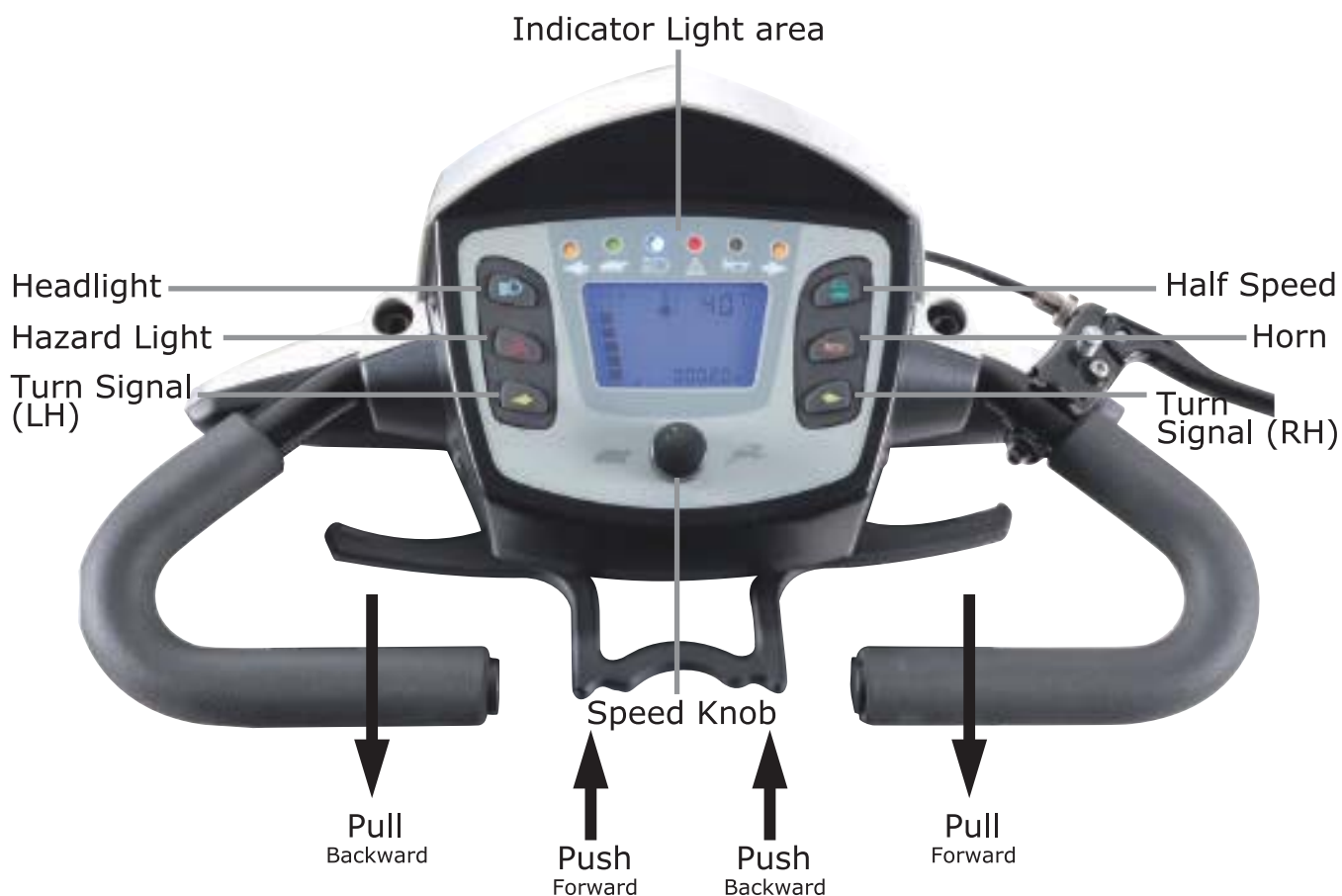

Note

The product of the driving function buttons, dial plate and handle, as the driver can operate on occupant or assistant operations.

3. YOUR SCOOTER

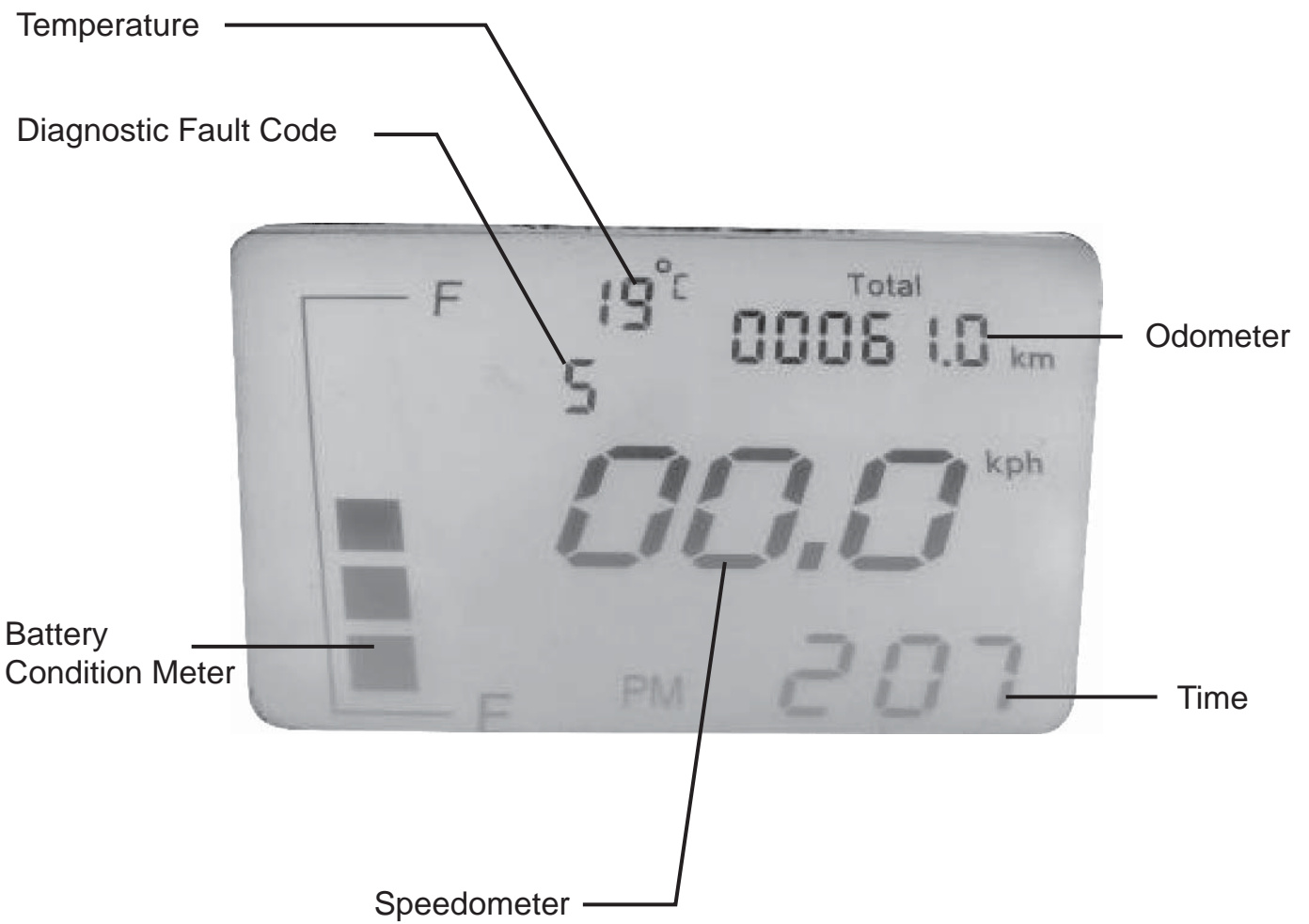

3. YOUR SCOOTER

Horn Button

The button activates a warning horn. The horn of the indicator light area will light up when pressing the button. Using the warning horn when doing so may prevent accident or injury.

Key Switch

Insert the key into the key switch and turn it clockwise to turn on your scooter. Turn the key counterclockwise to turn off your scooter.

LCD Display

The standard Display shows the battery condition, accumulated usage hours, temperature and maintenance messages.

- The optional advanced display shows the battery condition, speedometer, time, odometer, temperature and maintenance message.
- Battery condition: Be aware when the battery becomes depleted. Estimate the distance and expected time for your trip before you start. We recommend you charge the battery after finished using you scooter. (See 4. Battery and charging)
- Meter(Accumulated usage hours): The LCD display shows the time count.
- Temperature: You will know the temperature degree on the LCD display.
- Diagnostic fault code: It shows the status of your scooter, when you see the wrench icon flashing with the code number on LCD display.

Number of lights	Meaning
1	Battery needs recharging
2	Battery voltage is too low
3	Battery voltage is too high
4	Current limit time out /Controller over heat
5	Brake fault
6	Not in neutral at power up
7	Speed pot error
8	Motor volts error
9	Other internal error
10	Push too fast fault

It is important that you consult in case of error with your dealer. Except for 1 and 2 flashes. Then you need to recharge the batteries .On For all other errors, you need to ask your dealer what to do.

Warning:

Never repair your scooter yourself. When you do this, the warranty expires.

3. YOUR SCOOTER

Motor/Transaxle Assembly

The motor/transaxle assembly is an electromechanical unit that converts electrical energy from your scooter's batteries into the controlled mechanical energy that drives the scooter's wheels.

WARNING

Surface temperatures can increase when exposed to external sources of heat (e.g. sunlight)

Manual freewheel lever

Whenever you need or want to push your scooter for short distances, you can put it in freewheel mode.

1. Remove the key from the key switch.
2. Push the manual freewheel lever to disable the drive system and the brake system. You may now push your scooter.
3. Pull back on the manual freewheel lever to reengage the drive and the brake systems and take your scooter out of freewheel mode.

When your scooter is in freewheel mode, the braking system is disengaged.

Disengage the drive motors only on a level surface.

Ensure the key is removed from the key switch.

Stand to the side of the scooter to engage or disengage freewheel mode. Never sit on a scooter to do this.

After you have finished pushing your scooter, always return it to the drive mode to lock the brakes.



Disengage and in freewheel mode.



Engage and in drive mode.

WARNING

For your own safety, while driving the scooter, the occupant can not switch to freewheel mode, it will require the assistant for switching to freewheel mode.

3. YOUR SCOOTER

Failure to follow these instructions may result in damage to the scooter or serious injury.

■ Practice Before Operating

Find an open area such as a park and have an assistant to help you practice until you have confidence operating this vehicle.

Make sure the unit is OFF before getting on or off. Set the speed control knob according to your driving ability.

We recommend that you keep the speed at the slowest position (fully counter-clockwise) until you are familiar with the driving characteristics of this vehicle.



3. YOUR SCOOTER

This vehicle has an immunity level of 20 V/m which should protect it from Electromagnetic Interference(EMI) from Radio Wave Sources. The rapid development of electronics, especially in the area of communications, has saturated our environment with electromagnetic (radio) waves that are emitted by television, radio and communication signals. These EM waves are invisible and their strength increases as one approaches the source. All electrical conductors act as antennas to the EM signals and, to varying degrees, all power wheelchairs and scooters are susceptible to electromagnetic interference (EMI). This interference could result in abnormal, unintentional movement and/or erratic control of the vehicle. The United Statement be incorporated to the user's manual for all electric scooter.

Powered wheelchairs and electric scooters(in this text, both will be referred to as powered wheelchairs) may be susceptible to electromagnetic interference(EMI), which is interfering electromagnetic energy emitted from sources such as radio stations, TV stations, amateur radio (HAM) transmitters, two-way radios and cellular phones. The interference (from radio wave sources) can cause the powered wheelchair to release its brakes, move by itself or move in unintended directions. It can also permanently damage the powered wheelchair's control system. The intensity of the EM energy can be measured in volts per meter (V/m). Each powered wheelchair can resist EMI up to a certain intensity. This is called the "immunity level." The higher the immunity level, the greater the protection. At this time, current technology is capable of providing at least 20 V/m of immunity level which would provide useful protection against common sources of radiated EMI.

Following the warnings listed below should reduce the chance of unintended brake release or powered wheelchair movement that could result in serious injury:

- 1) Do not turn on hand-held personal communication devices such as citizens band (CB) radios and cellular phones while the powered wheelchair is turned on.
- 2) Be aware of nearby transmitters such as radio or TV stations and try to avoid coming close to them.

3. YOUR SCOOTER

- 3) If unintended movement or brake release occurs, turn the powered wheelchair off as soon as it is safe.
- 4) Be aware that adding accessories or components, or modifying the powered wheelchair, may make it more susceptible to interference from radio wave sources. (Note: there is no easy way to evaluate their effect on the overall immunity of the powered wheelchair).
- 5) Report all incidents of unintended movement or brake release to the powered wheelchair manufacturer, and note whether there is a radio wave source nearby.

WARNING

1. The scooter might disturb the operation of devices in its environment that EMIT electromagnetic fields (e.g. alarm systems of shops, automatic doors, etc.).
2. The driving performance of the scooter maybe influenced by electromagnetic fields (e.g. those emitted by portable telephones, electricity generators or high power sources).

TURN OFF YOUR SCOOTER AS SOON AS POSSIBLE WHEN EXPERIENCING ANY OF THE FOLLOWEING:

1. Unintentional motions.
2. Unintended or uncontrollable direction.
3. Unexpected brake release.

The FDA has written to the manufacturers of power wheelchairs, asking them to test their new products to be sure they provide a reasonable degree of immunity against EMI. The letter says that powered wheelchairs should have an immunity level of at least 20 V/m, which provide a reasonable degree of protection against the more common sources of EMI. The higher the level, the greater the protection.

3. YOUR SCOOTER

■ Safety Precautions

- ◆ Do not carry passengers or exceed the maximum weight limit of 204kg(450lbs).
- ◆ Do not exceed any incline over 10°. Ask for assistance when descending or ascending steep gradients.
- ◆ Do not attempt to mount a curb higher than 10 cm (4")
- ◆ Do not use on the road, except when crossing between pavements. When crossing the carriageway of a public road always take extra care and observe the highway code.
- ◆ Do not ride through water, or deep soft terrain (soft dirt, loose gravel, deep grass).
- ◆ Do not mount or dismount the scooter unless the brakes are engaged and the controls are switched off.
- ◆ Do not operate the scooter if the unit is in freewheel mode.
- ◆ Do not sit on your scooter when in a vehicle, but transfer to a vehicle seat and stow the scooter in the vehicle storage space.
- ◆ Do not turn suddenly at full speed. Always stop before making a sharp change of direction.
- ◆ Always engage a slow speed when going down gradients.
- ◆ Always keep your feet on the footplate when moving.
- ◆ Do not expose the scooter to direct rain or high humidity, as it may cause it to malfunction (electrically or mechanically).
- ◆ Always make sure that the batteries are sufficiently charged before setting out on a journey.
- ◆ Do not use parts, accessories or adapters other than those authorized by Merits.
- ◆ In any emergency of case, can use turn off the key switch to emergency stop the scooter.

4. BATTERY AND CHARGING

4. BATTERY AND CHARGING

Battery Wire Connection

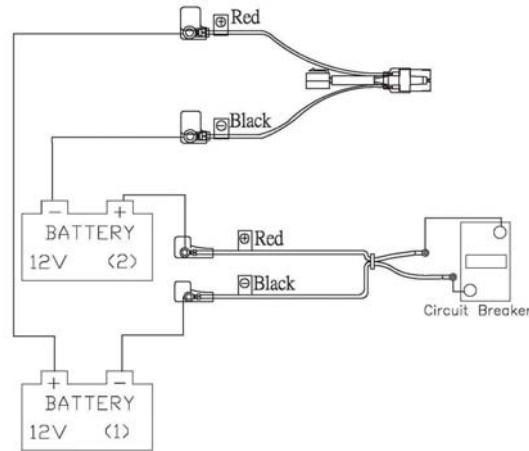

Your scooter is equipped with VRLA batteries. These batteries require no maintenance other than ensuring they are properly charged. If other batteries are used, check with your battery supplier for proper battery care and maintenance instructions.

Your scooter is supplied with one power cable & one circuit breaker cable. Attach the `power cable` red wire to the (+) terminal of the first battery. Attach the `power cable` black wire to the (-) terminal of the second battery. Attach the `circuit breaker cable` red wire to the (+) terminal of the second battery. Attach the `circuit breaker cable` black wire to the (-) terminal of the first battery. (Refer to diagram above)

! WARNING

Charge your scooter's batteries fully prior to using it for the first time. Keep the batteries fully charged to keep your scooter running smoothly.

Using off-board charger

Follow the steps to charge your batteries:

1. Position your scooter close to a standard electrical outlet.
2. Remove the key from the key switch.
3. Make certain that the manual freewheel lever is in the drive position.
4. Plug the 3-pin charger power cord into the off-board charger port.
5. Extend the charger power cord and plug it into the electrical outlet. We recommend that you charge the batteries for 8 to 14 hours. (Check the progress lights on the charge unit).
6. When the batteries are fully charged, unplug the charger power cord from the electrical outlet and then from the off-board charger port.

4. BATTERY AND CHARGING

!! PROHIBITED !!

- Never use an extension cord to plug in your battery charger. Plug the charger directly into a properly wired standard electrical outlet.
- Removal of the grounding prong can create an electrical hazard. If necessary, properly install an approved 3-pronged adapter to an electrical outlet having 2-pronged plug access.
- Do not allow unsupervised children to play near the scooter while the batteries are charging. We recommend that you do not charge the batteries while the scooter is occupied.

!! MANDATORY !!

Read the battery charging instructions in this manual and in the manual supplied with the battery charger before charging the batteries.



WARNING

- Inspect the battery charger, wiring, and connectors for damage before each use.
- Do not attempt to open the battery charger case. If the off-board battery charger is equipped with cooling slots, then do not attempt to insert objects through these slots.
- Use only the original battery charger, which was accompanied with your scooter.
- Do not operate the scooter with depleted batteries since the occupant could be stranded.

4. BATTERY AND CHARGING

Frequently asked questions

How does the charger work?

When your scooter's battery voltage is low, the charger works harder, sending more electrical current to the batteries to bring up their charge. As the batteries approach a full charge, the charger sends less and less electrical current. When the batteries are fully charged, the current sent from the charger is at nearly zero amperage. Therefore, when the charger is plugged in, it maintains the charge on your scooter's batteries, but does not overcharge them. We do not recommend that you charge your scooter's batteries for more than 24 consecutive hours.

Can I use a different charger?

Chargers are selected precisely for particular applications and are especially matched to the type, size, and chemical formulation of specific batteries. Any charging method resulting in batteries being charged individually is especially prohibited.

What if my scooter's batteries won't charge?

- Ensure the red (+) and black (-) battery cables are connected properly to the battery terminals.
- Ensure battery harnesses that extend from the batteries are plugged/ connected into their mating connector/ terminals.
- Ensure both ends of the charger power cord are inserted fully.

4. BATTERY AND CHARGING

How often must I charge the batteries?

When you decided to all day use your scooter on a basis or infrequent sporadic scooter use, with these considerations in mind, you can determine how often and for how long you should charge your scooter's batteries. We designed the off-board charger so that it will not overcharge your scooter's batteries. However, you may encounter some problems if you do not charge your batteries often enough and if you do not charge them on a regular basis. Following the guidelines below will provide safe and reliable battery operation and charging.

- If you use your scooter daily, charge its batteries as soon as you finish using it for the day. We recommend that you charge your scooter's batteries for 8 to 14 hours after daily use.
- If you use your scooter once a week or less, charge its batteries at least once a week for 12 to 14 hours at a time.
- Keep your scooter's batteries fully charged.
- Avoid deeply discharging your scooter's batteries.

How can I ensure maximum battery life?

Fully charged deep-cycle batteries provide reliable performance and extended battery life. Keep your scooter's batteries fully charged whenever possible. Protect your scooter and batteries from extreme heat or cold. Batteries that are regularly and deeply discharged, infrequently charged, stored in extreme temperatures, or stored without a full charge may be permanently damaged, causing unreliable performance and limited service life.

4. BATTERY AND CHARGING

How can I get maximum range or distance per charge?

Rarely will you have ideal driving conditions—smooth, flat, hard driving surfaces with no wind or curves. Often, you will face hills, pavement cracks, uneven and loosely packed surfaces, curves, and wind, all of which affect the distance or running time per battery charge. Below are a few suggestions for obtaining the maximum range per battery charge.

- Always fully charge your scooter's batteries prior to daily use.
- Maintain but do not exceed the psi/bar/kPa air pressure rating indicated on pneumatic tires.
- Plan your route ahead to avoid as many hills, cracked, broken or soft surfaces as possible.
- Limit your baggage weight to essential items.
- Try to maintain an even speed while your scooter is in motion.
- Avoid stop-and-go driving.

What type and size of battery should I use?

We recommend deep-cycle batteries that are sealed and maintenance free.

How do I change a battery in my scooter?

Battery posts, terminals, and related accessories contain lead and lead compounds. Wear goggles and gloves when handling batteries and wash hands after handling.

- Always use two batteries of the exact same type, chemistry, and amp-hour (Ah) capacity. Refer to the specifications table in this manual and in the manual supplied with the battery charger for recommended type and capacities.
- Contact your dealer if you have any questions regarding the batteries in your scooter.
- Do not replace the batteries while the scooter is occupied.
- Do not mix old and new batteries. Always replace both batteries at the same time.

5. OPERATION

5. OPERATION

Getting onto your scooter

1. Make certain that the key is removed from the key switch.

Never attempt to get onto or off of your scooter without first removing the key from the key switch. This will prevent the scooter from moving if accidental throttle control lever contact is made.

2. Stand at the side of your scooter.

3. Disengage the seat rotation lever and rotate the seat until it is facing you.

4. Make certain that the seat is fixed securely in position.

5. Position yourself comfortably and securely in the seat.

6. Disengage the seat rotation lever and rotate the seat until you are facing forward.

7. Make certain that your feet are safely on the floorboard.

Operating your scooter

Keep both hands on the tiller and your feet on the floorboard at all times while operating your scooter. This driving position gives you the most control over your vehicle.

- Set the speed adjustment dial to your desired speed.
- Push or pull the appropriate side of the throttle control lever.
- The electromechanical disc park brake automatically disengages and the scooter accelerates smoothly to the speed you preselected with the speed adjustment dial.
- Pull on the left handgrip to steer your scooter to the left.
- Pull on the right handgrip to steer your scooter to the right.
- Move the tiller to the center position to drive straight ahead.
- To stop, slowly release the throttle control lever. The electronic brakes will automatically engage, bringing your scooter to a stop.

WARNING

The following can adversely affect steering and stability while operating your scooter, resulting in loss of control or tipping:

- Holding onto or attaching a leash to walk your pet.
- Carrying passengers (including pets).
- Hanging any article from the tiller.
- Towing or being pushed by another motorized vehicle.

5. OPERATION

Getting off your scooter

1. Bring your scooter to a complete stop.
2. Remove the key from the key switch.
3. Disengage the seat rotation lever and rotate the seat until you are facing toward the side of your scooter.
4. Make certain that the seat is fixed securely in position.
5. Carefully and safely get out of the seat and stand to the side of your scooter.
6. You can leave the seat facing to the side to facilitate boarding your scooter next time.

Power down timer feature

Your scooter is equipped with an energy saving automatic power down timer feature designed to preserve your scooter's battery life. If you mistakenly leave the key in the key switch and in the "on" position but do not use your scooter for approximately 10 minutes, the scooter's controller shuts down automatically. Although the controller is shut down, power will still be supplied to the scooter's lighting system.

If the power down timer feature takes effect, perform the following steps to resume normal operation:

1. Remove the key from the key switch.
2. Reinsert the key and power up your scooter.

5. OPERATION

■ Disassembly of the scooter

This scooter can be separated into four parts, the main frame rear shroud, seat and the battery. Follow the procedures below to disassemble your scooter and transport it with care.

Scooter can be folded or dismantled to assist in storage or transport.

1. Main Frame
2. Rear Shroud
3. Seat
4. Battery



! WARNING

If components of the surface of the product (such as car cover, seat, armrest, joystick handles, etc.) exposure to the sun, this may causing high temperature on the part surface,the high temperatures may cause dangers. Please use the scooter after the tact, when the surface is cool down.

5. OPERATION

■ Disassembly and Assembly of the Scooter

Note: For disassembling battery or seat, it requires two people to operate the assembling. (Operations intended to be carried out by the occupant and/or assistant.)

For seat remove:

1. Both workers were required for seat removal from both left side and right side of the seat.
2. The worker at left hand side should handle the seat by holding the lower armrest tubes and bottom of the seat. (Fig A)
3. The worker at the right hand side should handle the seat by holding the lower armrest tubes and pull the seat releasing lever for releasing the seat locking device. (Fig B)
4. Both workers should lift up the seat at the same time to remove the seat from the scooter. (Fig C)
5. Both workers should move the seat together and place it on the flat ground. For seat installing, please follow the above steps in the reserve way. (Fig D)



Fig A



Fig B



Fig C



Fig D

5. OPERATION

For disassembling the covers:

1. Workers should lift up the cover. (Fig A)
2. Worker should remove the cover, place it on the flat ground.

For cover installing, please follow the above steps in the reserve way.



Fig A

For removing batteries:

1. Use '+' Screw driver disconnect power cable. (Fig A)
2. Use '+' Screw driver disconnect circuit breaker cable. (Fig B)
3. Tear apart the batteries velcro belts. (Fig C)
4. Both workers should lift up the battery at the same time to remove the battery from the scooter. (Fig D)
5. Both workers should move the batteries and place it on the flat ground.

For battery installation, please follow the above steps in the reserve way.

WARNING

For battery installation process, if the 'left' and 'right' battery cable are connected incorrectly (in the reverse way), it would result the failure of tiller functional, please re-check connections.



Fig A

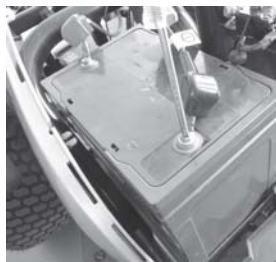

Fig B



Fig C



Fig D

5. OPERATION

Key switch

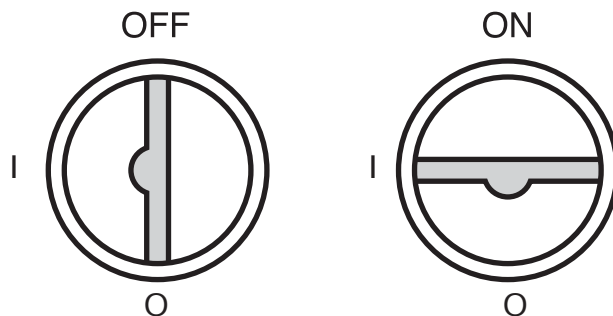

When the key is turned to a horizontal position, the scooter is ON and ready to drive. When the key is turned to a vertical position, the scooter is OFF.

Brakes and throttle control lever:

Whenever the speed lever is pushed, the electromagnetic brake will automatically release and your scooter will move. When the speed lever is released, it will return to the neutral position and the scooter will decelerate and come to a complete stop. The parking brake will then engage preventing further movement of your scooter.

Your unit is equipped with a programmable controller that has a high peddle disable feature. This will prevent unexpected acceleration of the scooter, if the speed lever is being pushed at the same time you turn the key 'ON'. To reset the controller, release the speed engage lever and turn the key 'OFF' for a couple of seconds and then turn it back 'ON'.



If your scooter ever moves in an unexpected manner, release the speed lever and turn off the power.

6. COMFORTABLE ADJUSTMENTS

6. COMFORTABLE ADJUSTMENTS

! WARNING

Warning: Be careful when you perform any adjustments to avoid any injury by squeezing your fingers. For removing the seat two persons should grip the seat.

Tiller angle adjustment

The tiller angle adjustment allows you to position the dash closer or further away from you for better access to the controls (See Picture 6.1).

1. Locate the angle adjusting lever where is located on the inside center of the tiller boot.
2. Hold the weight of the tiller with on hand and loosen the lever by pulling up the lever with the other hand. Pushing down will release the tiller locking mechanism, allowing you to move the tiller freely.
3. Release the lever and try to move the tiller back an forth slightly allowing the lever to lock.

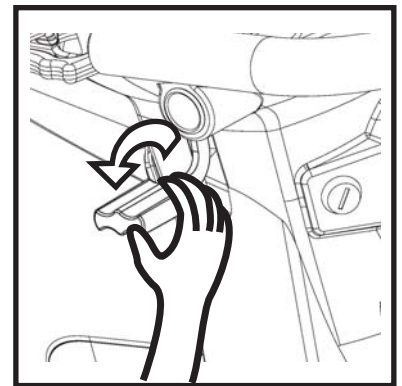

Picture 6.1

Seat rotation adjustment

The seat rotation lever will secure the seat into several positions. (See Picture 6.2)

1. Push the seat rotation lever to disengage the seat.
2. Rotate the seat to the desired position.
3. Release the lever to secure the seat into place.

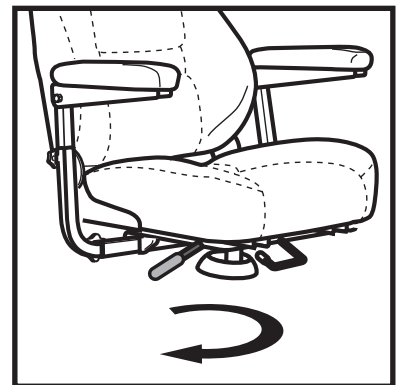

Picture 6.2

Back rest angle

Fold the backrest for easy access.
(See Picture 6.3)

Front-to-back seat adjustment

You can reposition the seat forward or rearward to adjust the distance between the seat and the tiller.

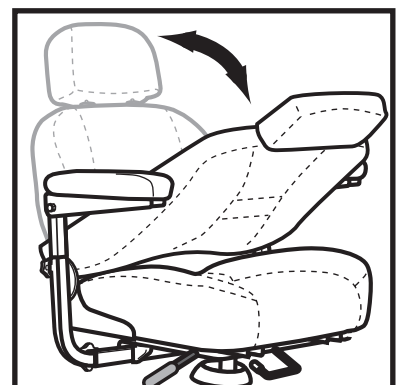

Picture 6.3

6. COMFORTABLE ADJUSTMENTS

Armrest width adjustment

The armrest width can be adjusted inward or outward.
(See Picture 6.4)

1. Loosen the armrest adjustment knobs.
 2. Slide the armrests in or out to the desired width.
 3. Align the adjustment holes on the seat frame and armrest.
 4. Tighten the armrest adjustment knobs as required.
- NOTE: Pivot the armrests upward to aid in getting onto and off of your scooter.

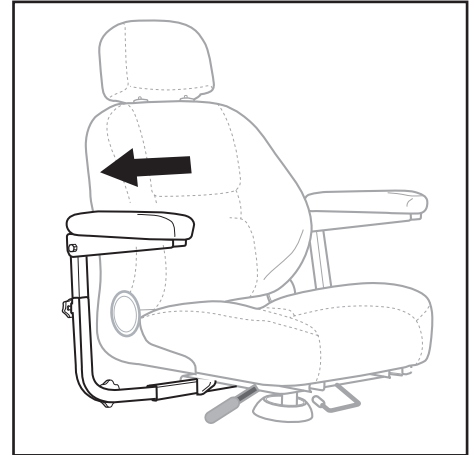

Picture 6.4

Armrest height adjustment

Loosen the clamping nut at the rear of the handle.
Turn the bolt into the lower the angle of the armrest to desired angle. (See Picture 6.5)



Picture 6.5

Seat height adjustment

The seat can be repositioned to different heights.

1. Remove the seat and rear shroud from your scooter.
2. Loosen the seat height adjustment nut and remove it from the bolt. Remove the bolt.
3. Raise or lower the upper seat post to the desired seat height.
4. While holding the upper seat post at that height, match up the locating holes in the upper seat post with those of the lower seat post.
5. Insert the seat height adjustment bolt through the locating holes of both the upper and lower seat posts.
7. Install the nut onto the bolt and tighten.
8. Reinstall the rear shroud and the seat.

6. COMFORTABLE ADJUSTMENTS

Mirror position

To install the mirror:

1. Insert the threaded end of the mirror holder into the opening and rotate it clockwise until snug.
2. If necessary, rotate the nut clockwise to secure the mirror in place.

To adjust the mirror:

1. Position yourself in a seated driving position facing forward.
2. Adjust the mirror left, right, up, or down until you have a good line of sight behind you.

Positioning belt (Optional)

Your scooter seat is equipped with an auto-type positioning belt that can be adjusted for operator comfort. The positioning belt is designed to help support the operator so that he/she does not slide down or forward in the seat.

Make sure the positioning belt is properly secured to the scooter and is adjusted for operator comfort.

7. CARE AND MAINTENANCE

7. CARE AND MAINTENANCE

Your scooter requires a minimal amount of care and maintenance. If you do not feel confident in your ability to perform the maintenance listed below, you may schedule inspection and maintenance at your authorized. The following areas require periodic inspection and/or care and maintenance.

Tire pressure

- If equipped with pneumatic tires, always maintain the 32psi/2.2bar/220kpa air pressure indicated on each tire.
- It is important that the 32psi/2.2bar/220kpa pressure indicated on each tire be maintained in pneumatic tires at all times. Do not underinflate or overinflate your tires.
- Low pressure may result in loss of control, and overinflated tires may burst. Failure to maintain the psi/bar/kPa air pressure indicated on pneumatic tires at all times may result in tire and/or wheel failure.
- Regularly inspect your scooter's tires for signs of wear.

Exterior surfaces

Bumpers, tires, and trim can benefit from an occasional application of rubber or vinyl conditioner.

Do not use a rubber or vinyl conditioner on the scooter's vinyl seat or tire tread, as this may cause them to become dangerously slippery.

7. CARE AND MAINTENANCE

Cleaning and disinfection

- Use a damp cloth and mild, non-abrasive cleanser to clean the plastic and metal parts of your scooter.

Avoid using products that may scratch the surface of your scooter.

- If necessary, clean your product with an approved disinfectant. Make sure the disinfectant is safe for use on your product before application.

- Follow all safety instructions for the proper use of the disinfectant and cleaning agent before applying it to your product. Failure to comply may result in skin irritation or premature deterioration of upholstery and/or scooter finishes.

Battery terminal connections

- Make certain that the terminal connections remain tight and uncorroded.

- The batteries must sit flat in the battery wells.

ABS plastic shrouds

- The front tiller shroud, front shroud, and the rear shroud are formed from durable ABS plastic and are coated with an advanced formula urethane paint.

- A light application of car wax will help the shrouds retain their high gloss.

Motor brushes

The motor brushes are housed inside of the motor transaxle/assembly. They should be inspected periodically for wear by your authorized dealer.

AXLE BEARINGS AND THE MOTOR/TRANSAXLE ASSEMBLY

You do not need to lubricate these items, as they are all prelubricated and sealed.

7. CARE AND MAINTENANCE

Wheel replacement

If your scooter is equipped with pneumatic tires and you have a flat tire, you can have the tube replaced.

If your scooter is equipped with a solid tire insert, either the solid insert or the entire wheel must be replaced depending on the model. Contact your dealer for information regarding replacement wheels for your scooter.

Be sure that the key is removed from the key switch and the scooter is not in freewheel mode before performing this procedure.

Follow these easy steps for a quick and safe repair for solid tires:

1. Remove the key from the key switch.
2. Elevate the side of the scooter of which you are removing the tire. Place wooden blocks under the frame to elevate the scooter.
3. Remove the drive wheel nut and washer from the axle.
4. Pull the wheel off the axle.
5. Slide the new wheel back onto the axle. Make sure that the axle key is in the axle slot.

Failure to ensure that the axle key is properly installed into the axle slot when mounting the wheel can result in electronic brake failure, personal injury, and product damage.

6. Reinstall the drive wheel nut and washer onto the axle and tighten. Make sure both the nut and washer are reinstalled and tightened properly.
7. Remove the block from beneath the scooter.

7. CARE AND MAINTENANCE

Wiring harnesses

- Regularly check all wiring connections.
- Regularly check all wiring insulation, including the charger power cord, for wear or damage.
- Have your authorized dealer repair or replace any damaged connector, connection, or insulation that you find before using your scooter again.
- Even though the scooter has passed the necessary testing requirements for ingress of liquids, you should keep electrical connections away from sources of dampness, including direct exposure to water or bodily fluids and incontinence. Check electrical components frequently for signs of corrosion and replace as necessary.

LCD Setting procedure (Only for optional advanced LCD display)

- A. Key switch off.
- B. Keep pressing both head light button and half speed button for 3 seconds and key switch on
- C. Release both head light button and half speed button, the display is now in setting mode.
- D. Press hazard light button once at a time to choose the item you want to set. (The items are AM/PM, hour, minute, °C/°F, km/mile and kph/mpg.)
- E. Press left indicator button or right indicator button to change the setting.
- F. Leave all buttons for more than 5 seconds, the display will automatically go back to drive mode and store the settings.

Nylon lock nut replacement

Any nylon insert lock nut removed during the periodic maintenance, assembly, or disassembly of the scooter must be replaced with a new nut. Nylon insert lock nuts should not be reused as it may cause damage to the nylon insert, resulting in a less secure fit. Replacement nylon insert lock nuts are available at local hardware stores or through your dealer.

7. CARE AND MAINTENANCE

Console, charger, and electronic controller module

- Keep these areas away from moisture.
- Before operating your scooter, allow any of these areas to dry thoroughly if they have been exposed to moisture.

Fuses

To replace a fuse:

1. Remove the fuse by pulling it straight out of its slot.
2. Examine the fuse to be sure it is blown.
3. Insert a new fuse of the proper rating.

Storing your scooter

If you plan on not using your scooter for an extended period of time, it is best to:

1. Fully charge its batteries prior to storage.
2. Disconnect the batteries from the scooter.
3. Store your scooter in a warm, dry environment.
4. Avoid storing your scooter where it will be exposed to temperature extremes.

Always protect batteries from freezing temperatures and never charge a frozen battery. Charging a frozen battery can result in damage to the battery.

Recycle

According to local government information on the recycling of used batteries and other parts of the scooter; use only special recycling for the scooter parts, no general disposal (e.g. batteries, electronics)

Recommended storage and shipping temperature: Dry(15%~95% Non-Condensing), Well ventialed area -20°C~60°C(-4°F~140°F) Without batteries.

If you intend to use public transportation with your scooter, you must contact the transportation provider in advance to determine their specific requirements.

8. LIMITED WARRANTY

8. LIMITED WARRANTY

Corporation warrants to the original purchaser of this wheelchair product that it is free of defects in material and workmanship and that, when operated within the guidelines and restrictions of this manual, will remain free of defects in material and workmanship for a period of One (1) year from the original date of purchase.





Excluded from this warranty is failure due to negligence, abuse, accident, operation outside of rated limits, commercial or institutional use, damage / wear to upholstery or tires and improper maintenance or storage. The batteries for this wheelchair product are not supplied by Corporation; contact the battery manufacturer / supplier if warranty replacement is requested.

This wheelchair product must not be modified in any way without the express written consent of Corporation. Any such unauthorized modification could cause unreliable and / or unsafe operation and will void this warranty.

Where a failure occurs within the 1- year warranty period that is not excluded above, the failed components will be replaced with similar new or reconditioned components at sole option. Corporation will not be responsible for labor and / or shipping charges.

The foregoing warranty is exclusive and in lieu of all other warranties expressed or implied including, but not limited to, the implied warranty of merchantability and fitness for a particular purpose. Corporation is not liable for any consequential or incidental damages whatsoever.

Note: Service life of the frame and seat is 3 years.

IEC SYMBOLS	
	Caution, attention or consult accompanying documents.
	Alternating Current
	Double Insulation
	No Smoking or Naked Flames

Degree of protection against ingress of water is rated as IPx4.

